

Features

1. AC inputs.
2. Opaque type, mini-flat package.
3. Subminiature type (The volume is smaller than that of our conventional DIP type by as far as 30%)
4. Isolation voltage between input and output (Viso:3750Vrms).

Applications

1. Hybrid substrates that require high density mounting.
2. Programmable controllers.

Classification table of current transfer ratio is shown below.

RANK MARK	CTR(%)
A	50 TO 150
B	20 TO 400

Outside Dimension : Unit (mm)

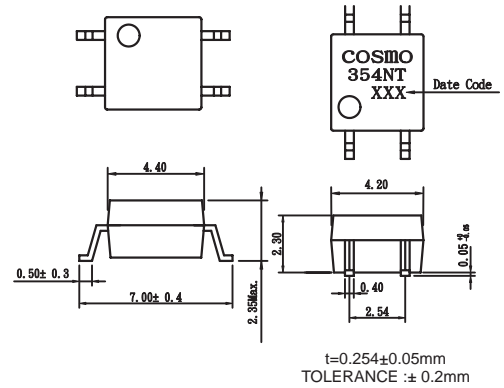

Schematic : Top View

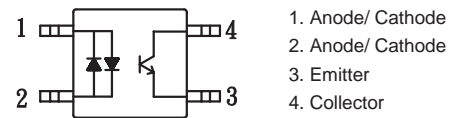

Absolute Maximum Ratings

(Ta=25°C)

Parameter		Symbol	Rating	Unit
Input	Forward current	IF	± 50	mA
	Peak forward current	IFM	± 1	A
	Power dissipation	P	70	mW
Output	Collector-emitter voltage	VCEO	60	V
	Emitter-collector voltage	VECO	5	V
	Collector current	IC	50	mA
	Collector power dissipation	PC	150	mW
Total power dissipation		Ptot	170	mW
Isolation voltage 1 minute		Viso	3750	Vrms
Operating temperature		Topr	-30 to +100	°C
Storage temperature		Tstg	-40 to +125	°C
Soldering temperature 10 second		Tsol	260	°C

Electro-optical Characteristics

(Ta=25°C)

Parameter		Symbol	Conditions	MIN.	TYP.	MAX.	Unit
Input	Forward voltage	VF	IF = ± 20mA	—	1.2	1.4	V
	Terminal capacitance	Ct	V = 0, f = 1kHz	—	30	250	pF
Output	Collector dark current	ICEO	VCE = 20V, IF = 0	—	—	0.1	uA
	Collector-emitter breakdown voltage	BVCEO	IC = 0.1mA, IF = 0	60	—	—	V
	Emitter- collector breakdown voltage	BVECO	IE = 100uA, IF = 0	5	—	—	V
Transfer characteristics	Current transfer ratio	CTR	IF = ± 1mA, VCE = 5V	20	—	400	%
	Collector-emitter saturation voltage	VCE (sat)	IF = ± 20mA, IC = 1mA	—	0.1	0.3	V
	Isolation resistance	Riso	DC500V, 40 to 60%RH	5X10 ¹⁰	10 ¹¹	—	ohm
	Floating capacitance	Cf	V = 0, f = 1MHz	—	0.6	1.0	pF
	Response time (Rise)	tr	VCE = 2V, IC = 2mA, RL = 100ohm	—	4	18	us
	Response time (Fall)	tf		—	3	18	us

Fig.1 Forward Current vs. Ambient Temperature

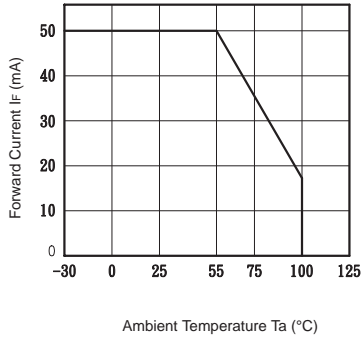

Fig.2 Diode Power Dissipation vs. Ambient Temperature

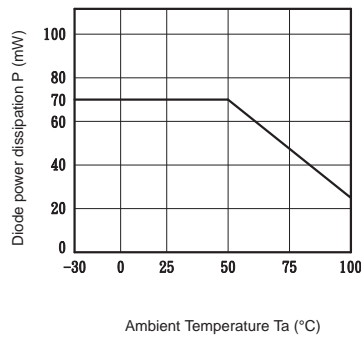

Fig.3 Collector Power Dissipation vs. Ambient Temperature

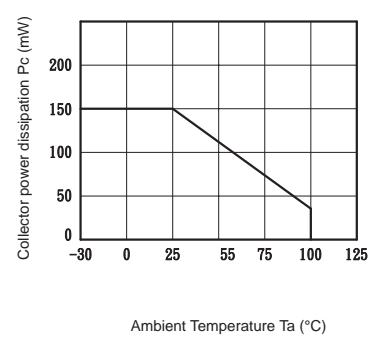

Fig.4 Total Power Dissipation vs. Ambient Temperature

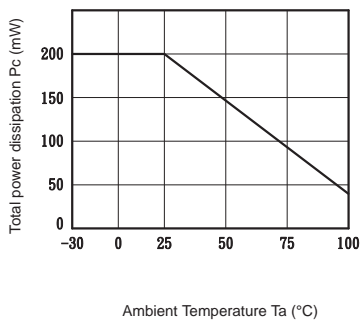

Fig.5 Peak Forward Current vs. Duty Ratio

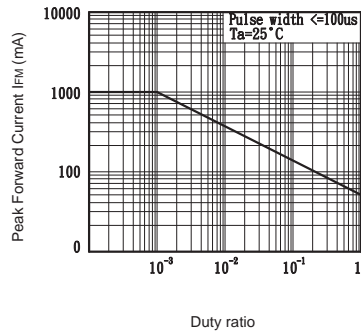

Fig.6 Forward Current vs. Forward Voltage

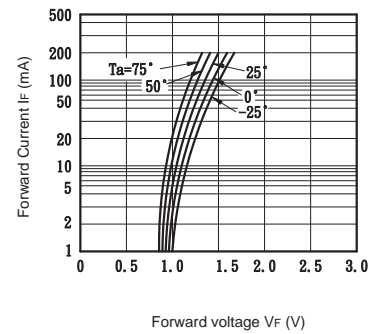

Fig.7 Current Transfer Ratio vs. Forward Current

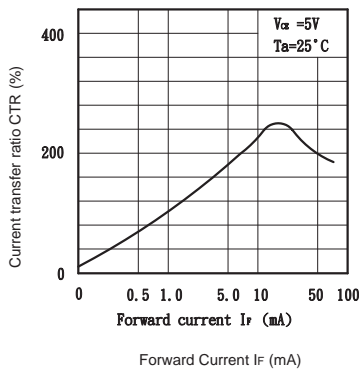

Fig.8 Collector Current vs. Collector-emitter Voltage

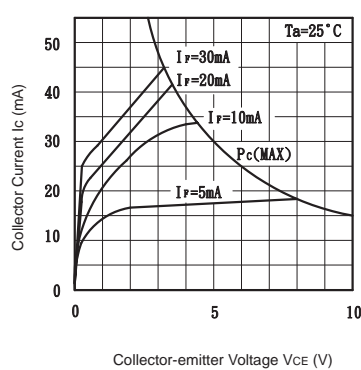

Fig.9 Relative Current Transfer Ratio vs. Ambient Temperature

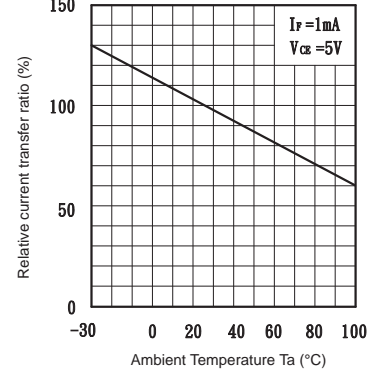

Fig.10 Collector-emitter Saturation Voltage vs. Ambient Temperature

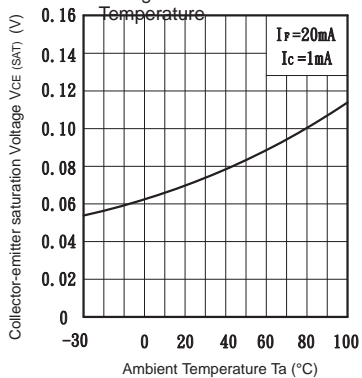

Fig.11 Collector Dark Current vs. Ambient Temperature

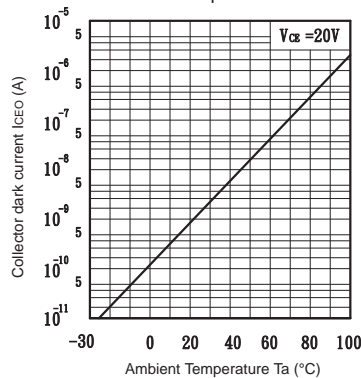

Fig.12 Response Time vs. Load Resistance

